

# MiniPCleCAN-2E-U

## MiniPCle Interface CAN Card

UM01010101 V1.05 Date: 2020/11/04

Product User Manual

Category	Contents
Keywords	MiniPCle and CAN message monitoring
Description	MiniPCle interface CAN card

### Revision History

Version	Date	Reason
V0.00	July 1, 2015	Created
V1.01	September 30, 2015	Added quick instructions and dynamic library usage.
V1.02	August 9, 2017	Changed the company name, sales and service network
V1.03	September 3, 2018	Modified product dimensions.
V1.04	March 12, 2019	Updated the document header and footer and "Sales and Service Network" content and added the "Disclaimer" content
V1.05	November 04, 2020.	Added the MiniPCle slot description

## Contents

1. Functions .....	2
1.1 Typical application .....	3
2. Equipment Installation.....	4
2.1 Power Supply.....	4
2.2 Signal Indicators .....	4
2.3 MiniPCle Interface Definitions .....	5
2.4 CAN Second Function Pin Switch .....	5
3. Driver Installation .....	7
3.1 Driver Installation .....	7
3.2 Uninstalling the Device Driver .....	11
4. Quick Instructions .....	12
4.1 CANTest Basic Operations.....	12
4.1.1 Device Type Selection.....	12
4.1.2 Filter Settings .....	13
4.1.3 Starting the CAN .....	14
4.1.4 Getting Device Information.....	14
4.2 Sending and Receiving Test.....	14
4.2.1 Establishing a Test Environment.....	14
4.2.2 Starting the Device .....	16
4.2.3 Sending Data.....	18
4.2.4 Real-time Saving and Stopping Saving .....	19
4.2.5 DBC Decoding and Display by ID .....	19
4.2.6 Bus Utilization.....	20
4.2.7 Error Message Display .....	20
5. Method of Using The Interface Library Functions .....	22
5.1 Methods of Calling the Dynamic Library on Windows.....	22
5.1.1 Methods of VC Calling the Dynamic Library .....	22
5.1.2 Method of VB Calling the Dynamic Library .....	22
5.2 Interface Library Function Usage Process .....	24
6. Electrical Characteristics.....	25
7. Structure and Dimensions.....	26
8. Inspection and Maintenance .....	28
9. Disclaimer .....	31
Appendix A ARM standard baud rate .....	32

## 1. Functions

MiniPCleCAN-2E-U is a high-performance MiniPCle interface CAN card launched by ZLG Electronics, which can connect the CAN network to a computer equipped with a MiniPCle card slot. MiniPCleCAN-2E-U adopts the MiniPCle board in standard dimensions and can be easily installed on laptop or industrial computer with MiniPCle interface, making it a powerful CAN analyzer. See the figure. .

MiniPCleCAN-2E-U integrates two CAN interfaces. In addition, to facilitate expansion, the second function pin of the CAN signal can be switched to the reserved IO port of the MiniPCle interface by using the resistor R24, which helps the user design the CAN transceiver circuit on the backplane.

The MiniPCleCAN-2E-U high-performance CAN interface card can be used to connect the PC to the CAN-bus network through USB bus, which constitutes a CAN-bus network control node for data processing and data acquisition in CAN-bus network fields such as fieldbus laboratories, industrial control, high-performance residential areas, and automotive electronic networks.

The MiniPCleCAN-2E-U high-performance CAN interface card is a powerful tool for CAN-bus product development and CAN-bus data analysis; moreover, it features small size, plug and play, etc. It is ideal for portable system users.

The MiniPCleCAN-2E-U high-performance CAN interface card supports Windows 2000/XP/7/8/10 and other operating systems. MiniPCleCAN-2E-U provides a unified application programming interface and complete application demonstration codes, including VC, VB, Delphi and C++ development routine demonstrations, which helps users develop application programs.

The MiniPCleCAN-2E-U interface card supports the CANTest general test software, which can perform functions such as sending, receiving and monitoring CAN-bus messages.

The MiniPCEeCAN card uses the USB D+ and USB D- signal cable in the MiniPCle slot. Before purchasing and using the product, check whether the MiniPCle slot on the motherboard provides USB D+ and USB D- signal pins. See Table 2.3 for pin numbers. This CAN card cannot be used if the USB signal pin is missing from the motherboard slot.



Figure 1.1 Product functions

- Adopt the standard MiniPCle interface;
- Support CAN2.0A and CAN2.0B protocols, in line with ISO/DIS11898 specification;
- Integrated two CAN-bus interfaces;
- The CAN TTL signal can be switched to the second function IO, which helps design the CAN transceiver circuit by yourself;
- The CAN-bus communication baud rate can be arbitrarily programmable between 5 Kbps and 1 Mbps;
- Powered by the MiniPCle interface;
- The CAN-bus interface is electrically isolated. The insulation voltage of the isolation module is 2,500 V DC;
- Support Windows 2000, Windows XP, Windows 7, Windows 8, Windows 10 operating systems;
- Support the CANtest test software;
- Compact, plug and play;
- Operating temperature: -40°C to 85°C;
- Standard MiniPCle card dimensions: 30 mm (width) x 50.95 mm (length).

## 1.1 Typical application

- CAN-bus network diagnosis and test;
- Automotive electronics applications;
- Electrical communication;
- Network industrial control equipment;
- High-speed, large data volume communication.

## 2. Equipment Installation

### 2.1 Power Supply

MiniPCleCAN-2E-U uses the MiniPCle interface 3.3V power supply. The SYS indicator is on, and it turns red first, indicating that the device has power supply. It then flashes a few times and turns green, indicating communication with the PC.

### 2.2 Signal Indicators

The MiniPCleCAN-2E-U interface card has one dual-color SYS indicator, one dual-color CAN0 indicator, and one dual-color CAN1 indicator, which indicate the running status of the device. Table 2.1 lists the functions of the indicators. When the indicators are in various states, the status of the CAN bus is shown in Table 2.2.

Table 2.1 Indicator functions

Indicator	STATUS	Indication status
SYS	Red	Device initialization status indication
	Green	MiniPCle interface signal indication
CAN1	Green	The CAN interface is working properly
	Red	The CAN interface is faulty
CAN2	Green	The CAN interface is working properly
	Red	The CAN interface is faulty

After the MiniPCleCAN-2E-U interface card is powered on, the system initialization status indicator SYS is red, indicating that the device has been powered and the system is initializing; If the system initialization status indicator SYS is off, a system power fault or serious system error occurs.

After normal connection to the PC, the SYS indicator is green. When data is being transmitted on the USB interface, the USB signal indicator SYS flashes in green.

When CAN1 and CAN21 indicators are green, the CAN controller has been initialized and is working properly.

When the CAN controller has an error, the CAN1 and CAN2 indicators are red; when the error of the CAN controller is cleared, the CAN1 and CAN2 indicators are green.

Table 2.2 CAN bus status

CAN indicator status	CAN bus status
CAN1, CAN2 are all off	The CAN controller is disconnected from the bus
CAN1 and CAN2 flash alternately in red and green	The CAN controller is not started, and the user is prompted to start the CAN controller
CAN1 and CAN2 indicators are always green	The CAN bus is operating properly
CAN1, CAN2 The red indicator flashes	The CAN-bus bus has an error or data overflow, and it may lose frames

### 2.3 MiniPCle Interface Definitions



Figure 2.1 MiniPCle pin sequence

Table 2.3 MiniPCle interface definition

Signal Name	Pin No.	Description
nWAKE	1	nWAKE signal/default pull-up
nRESET	22	nRESET signal/not used
TD0_REV	17	CAN0 TD second function IO
RD0_REV	19	CAN0 RD second function IO
TD1_REV	37	CAN1 TD second function IO
RD1_REV	39	CAN1 RD second function IO
USB_D-	36	USB_D-
USB_D+	38	USB_D+
3.3V	2, 24, 52	Power supply
GND	9, 15, 18, 21, 26, 27, 29, 34, 35, 40, 50	Ground

### 2.4 CAN Second Function Pin Switch

When designing the CAN transceiver circuit or improving the protection level of the CAN signal cable, consider connecting the second function pin of the CAN signal to the backplane through the MiniPCle reserved pin. Design the CAN transceiver circuit by yourself to improve the system flexibility.

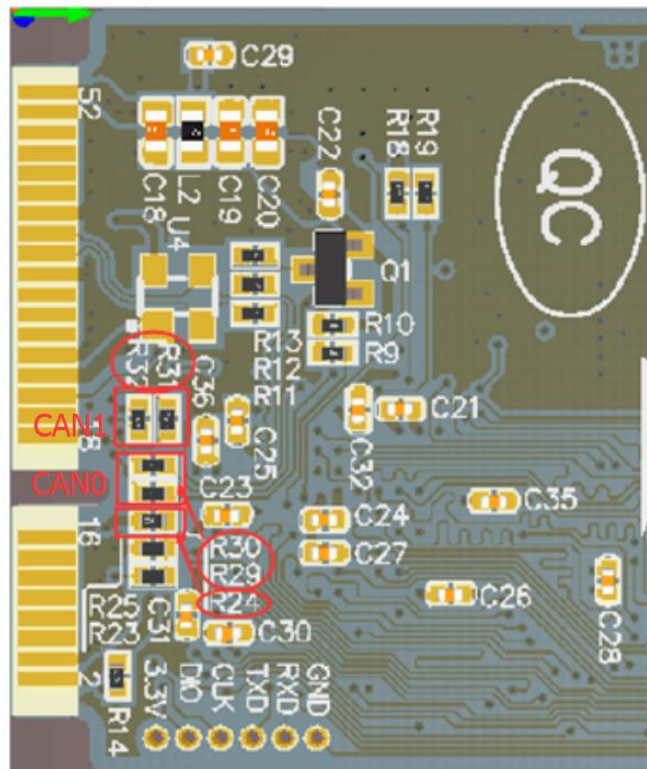

Figure 2.2 CAN signal secondary function selection resistor

The second function pin of the CAN signal is switched by using R24 (this resistor can be found on the rear of the board, as shown in Figure 2.2). R24 is welded by default. The system uses the default on-board CAN transceiver ADM3053. When R24 is removed, the second function pin of the CAN signal is automatically enabled when the system is powered on. Table 2.3 lists the pin sequence. At this time, R29 and R30 need to weld 0 ohm resistors to enable CAN0, while R31 and R32 respectively weld 0 ohm resistors to enable CAN1.



### 3. Driver Installation

The following uses a PC running WinXP as an example to illustrate how to install a MiniPCleCAN-2E-U series industrial-grade high-performance CAN interface card device correctly.

#### 3.1 Driver Installation

Windows XP can automatically detect new devices (as shown in Figure 3.1) and activate the "Found New Hardware Wizard" program to install plug-and-play device drivers (as shown in Figure 3.2). If the system does not prompt to discover a new device at this time, check whether the hardware is installed properly.



Figure 3.1 Discovering new hardware on Windows XP

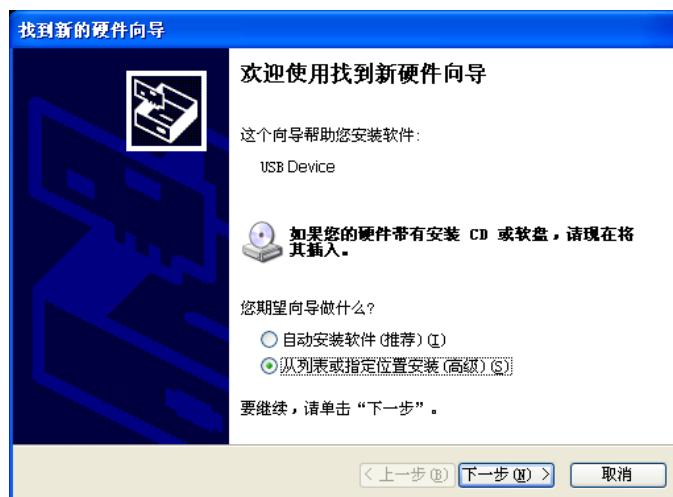

Figure 3.2 New Hardware Driver Installation Wizard

Select "Install from a list or specified location", and click "Next". See Figure 3.3.



Figure 3.3 Getting the driver file directory

Mark "Include this location in search" and click the "Browse" button. In the displayed folder browsing dialog box, specify the location of the driver installation file (the location of the driver in the product CD-ROM is MiniPCleCAN-2E-U\drivers\XP driver, and MiniPCleCAN-2E-U is the USBCAN-2E-U Derivatives, therefore sharing a single driver). Click Next. See Figure 3.4.

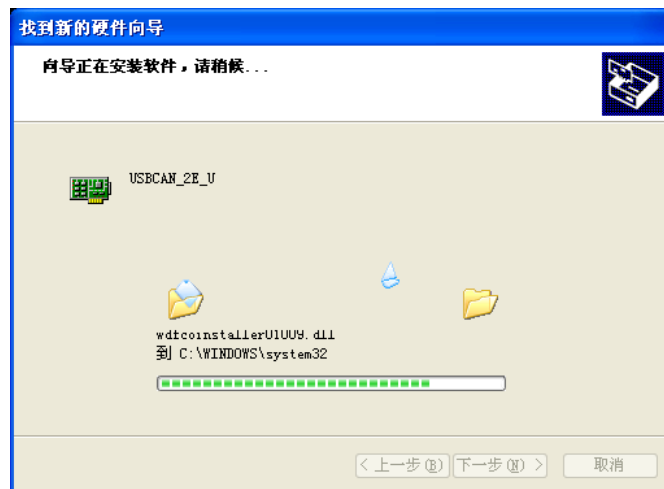

Figure 3.4 Installing the driver

Wait until the installation wizard installs the driver. The next window shows the installed devices. If the "Found New Hardware Wizard" message appears, the driver has been installed. Click the "Finish" button to complete the installation. See Figure 3.5



Figure 3.5 Driver installation complete

Check the device installation in "Start > Control Panel > System". Click the "Hardware" tab, and click the "Device Manager" button. See Figure 3.6 and Figure 3.7.

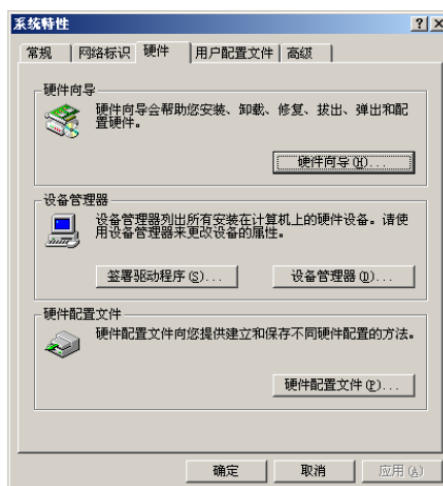

Figure 3.6 Hardware Wizard

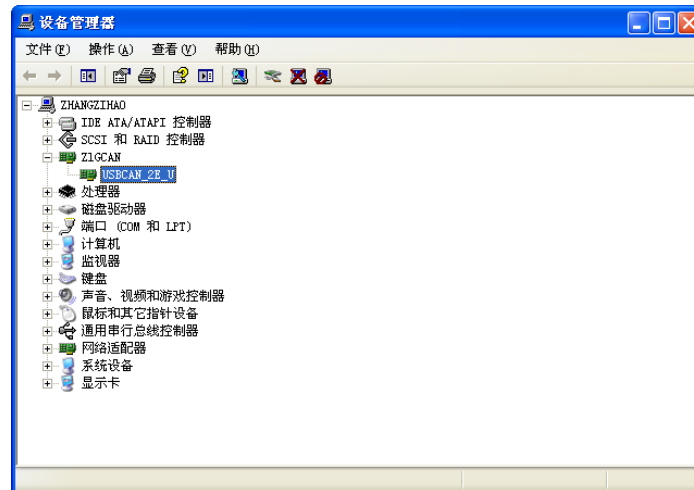

Figure 3.7 Checking device driver installation

### 3.2 Uninstalling the Device Driver

You can uninstall the device driver in "Start > Control Panel > System". Click the "Hardware" tab, and click the "Device Manager" button. See Figure 3.8.

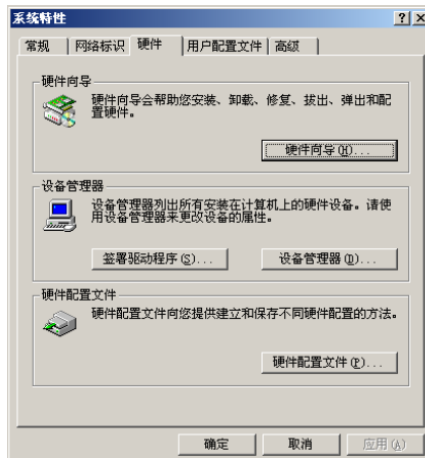

Figure 3.8 Hardware wizard

Right-click "USBCAN-2E-U" and choose "Uninstall". See Figure 3.9.

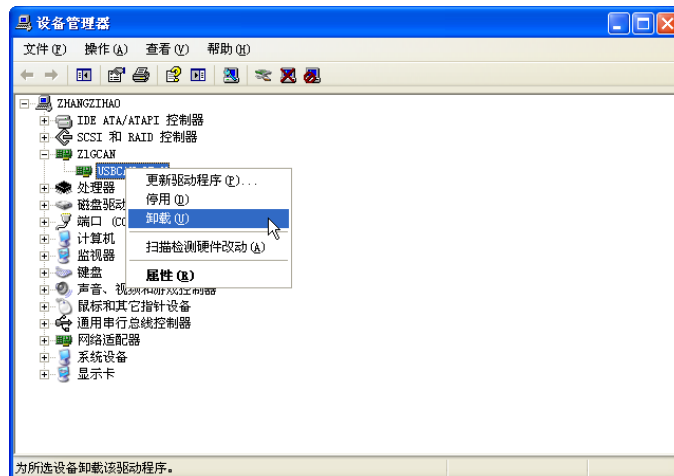

Figure 3.9 Unloading the device driver

In the Confirm Device Removal dialog box, click OK. The driver for USBCAN-2E-U will be uninstalled. Device Manager will be automatically refreshed and show that the device has been removed. See Figure 3.10.

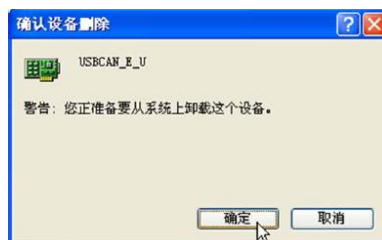

Figure 3.10 Confirming device driver uninstallation

## 4. Quick Instructions

### 4.1 CANTest Basic Operations

The CANTest test software can be found in the supporting CD-ROM (need to be installed). See Figure 4.1.

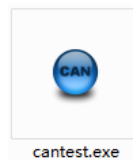

Figure 4.1 CANTest software icon

Note: The download address of CANTest software is [http://www.zlg.cn/canbus/product\\_detail.php?id=4](http://www.zlg.cn/canbus/product_detail.php?id=4).

#### 4.1.1 Device Type Selection

Before operation, select USBCAN-2E-U from the "Select Device" menu, as shown in Figure 4.2.



Figure 4.2 Device type selection

The "Open Device" dialog box is displayed, as shown in Figure 4.3.



Figure 4.3 Open Device dialog box

In this dialog box, select the device index number and CAN channel to be opened, and set the CAN initialization parameters, click "OK" to open the device operation window (or you can click the "OK and start CAN" button to open the device operation window and automatically start the device and start the CAN channel).

### 4.1.2 Filter Settings

In the device operation window, click the "Filter Settings" button to set the filter (if you do not need to set the filter, you can skip this step), as shown in Figure 4.4.

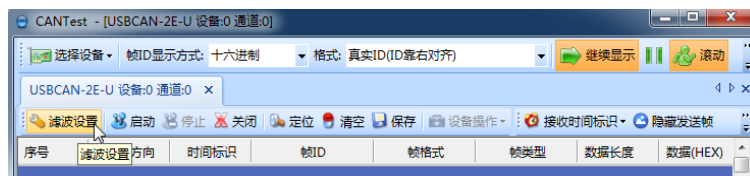

Figure 4.4 Filter Setting 1

The Filter Settings dialog box is displayed, as shown in Figure 4.5.

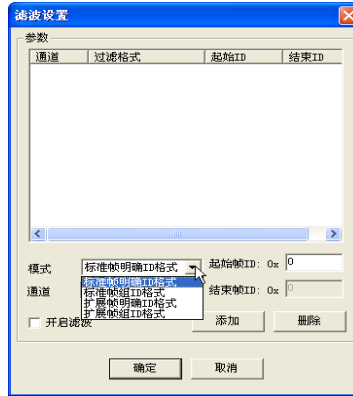

Figure 4.5 Filter Setting 2

Select the filter mode. Set the CAN frame to be filtered by setting the filter.

### 4.1.3 Starting the CAN

Click the "Start" button to start the CAN channel. The received CAN data is automatically displayed in the data list, as shown in Figure 4.6.

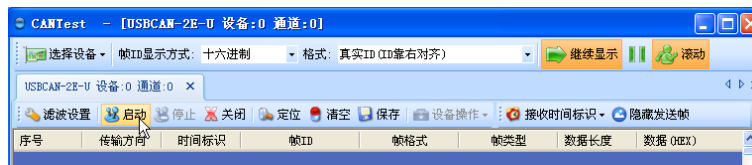

Figure 4.6 Startup

### 4.1.4 Getting Device Information

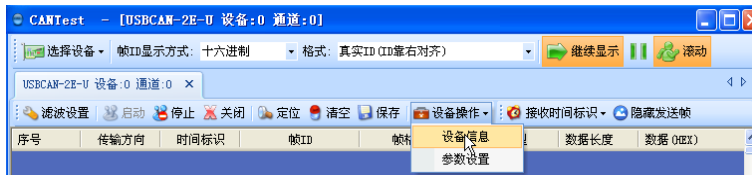

Figure 4.7 Device information

After starting the CAN channel, select the "Device Information" option in the "Device Operation" menu to obtain the details of the current device, as shown in Figure 4.7.

## 4.2 Sending and Receiving Test

This section describes the simple transmit-receive test, DBC decoding, and bus utilization of MiniPCleCAN-2E-U.

### 4.2.1 Establishing a Test Environment

Ensure that the wiring is correct. Figure 4.8 shows the interface definition, and Figure 4.9 shows the wiring effect.



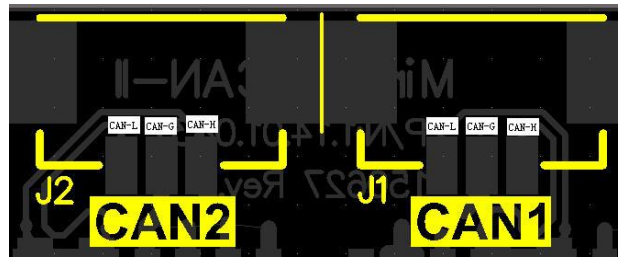

Figure 4.8 Interface definition

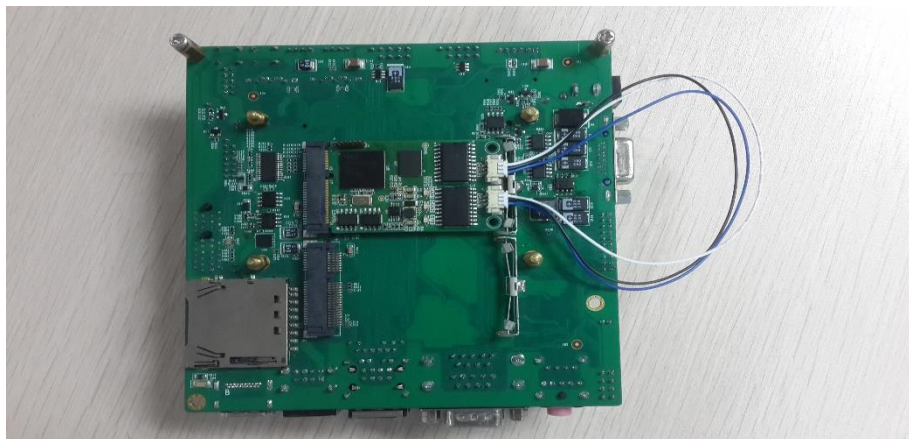

Figure 4.9 Wiring diagram

In this document, it is built based on our company's core board and backplane. In fact, the driver can be installed as long as the device connected to the MiniPCle interface is installed. Figure 4.10 and Figure 4.11 show the overall effect.



Figure 4.10 Wiring diagram



Figure 4.11 Wiring diagram

### 4.2.2 Starting the Device

Run the CANTest software and select the device type. See 4.1.1 Summary. Configure the device, as shown in Figure 4.12 and Figure 4.13. Pay attention to the selection of CAN channels. The device index number is a code that identifies the device. The same device index number should be selected for different CAN interfaces of the same device. Different device index numbers are selected for different devices select. Generally, device index numbers start from 0. The number of CAN channels is used to distinguish different CAN channels under the same device index number. This device has two CAN channels. Therefore, there are two options (0 and 1) in the first few CAN options. The baud rate is 100K. Since there is no terminal resistor installed for this test, the baud rate should not exceed 100K. If you really use it, you must add a terminal resistor of the corresponding resistance value.

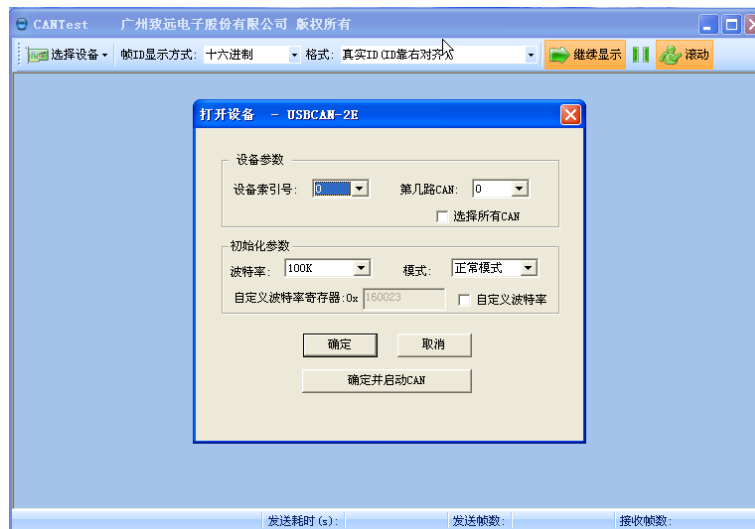

Figure 4.12 Parameter setting of the first channel CAN



Figure 4.13 Parameter setting of the second channel CAN

### 4.2.3 Sending Data

When you start the CAN successfully, set the parameters of the CAN frame you want to send, as shown in Figure 4.14. Click the "Send" button to send the data(The self-sent and self-receive option in the Sending Format drop-down box indicates that the sent CAN frame can also be received by itself. This option is only needed during testing; select normal transmission in practical applications).

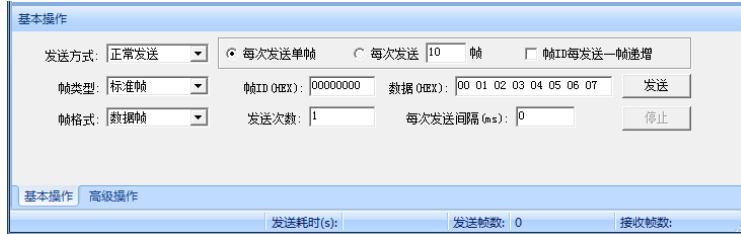

Figure 4.14 Basic settings for sending data

Click the "Advanced Operation" tab to display the advanced operation page. On this page, you can set to send multiple different CAN frames each time (a maximum of 100 frames can be set), and the interval between each frame and between each batch, as shown in Figure 4.15.

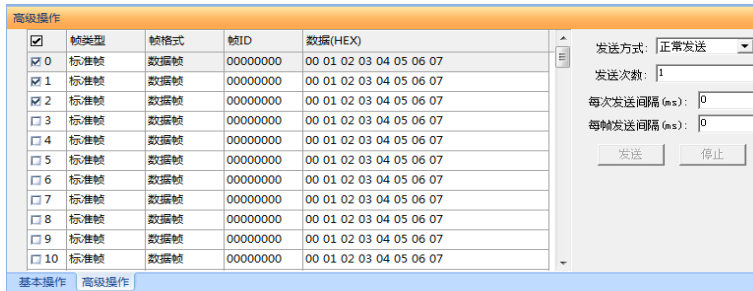

Figure 4.15 Advanced settings for sending data

Figure 4.16 and Figure 4.17 show the sending and receiving effect.

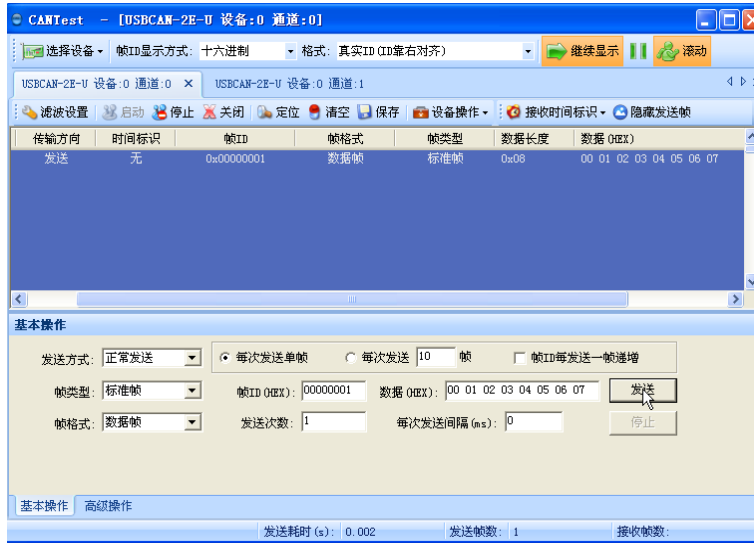

Figure 4.16 Sending



Figure 4.17 Receiving

### 4.2.4 Real-time Saving and Stopping Saving

When you need to record messages for a long time, use the real-time saving function. When the software buffer is full, transfer it to the file (CSV format) in the hard disk, and clear the software buffer. The message file names can be automatically numbered sequentially. Enable this function before starting. **Note that the save location cannot be specified in the C drive. Otherwise, saving may fail.** When you click Stop Saving, the transfer will not be performed, as shown in Figure 4.18.

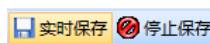



Figure 4.18 Saving

### 4.2.5 DBC Decoding and Display by ID

If you click , the DBC interface appears. You can import the required DBC file for frame decoding (the decoding is displayed at the bottom of the interface. **J1939 decoding is included by default**). Or, use this interface to display CAN frames by ID classification, that is, "ID fixed, data changes". Data segments with changes will be marked in red. See Figure 4.19.

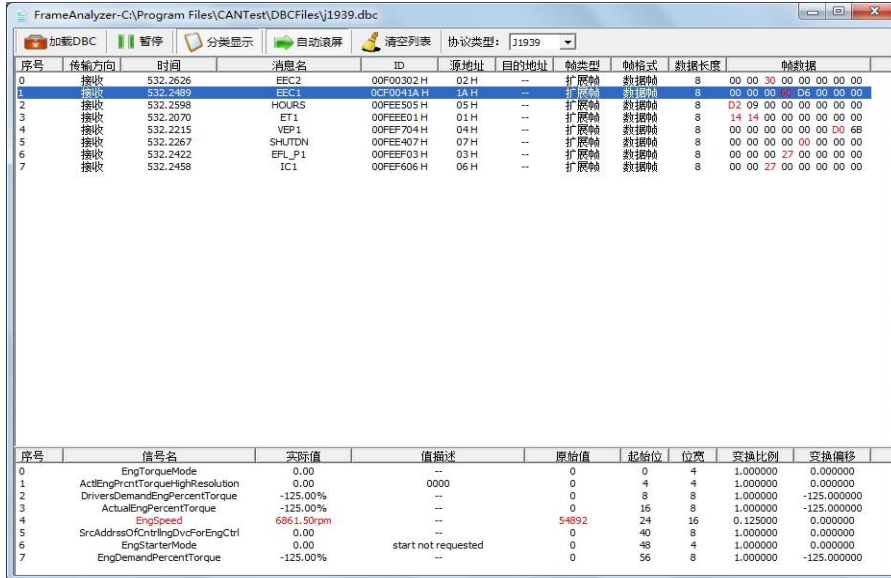



Figure 4.19 DBC protocol analysis

### 4.2.6 Bus Utilization

Click  to display the bus utilization interface. The current bus utilization and frame traffic can be monitored in real time. The refresh time can be adjusted to adjust the display speed. See Figure 4.20.

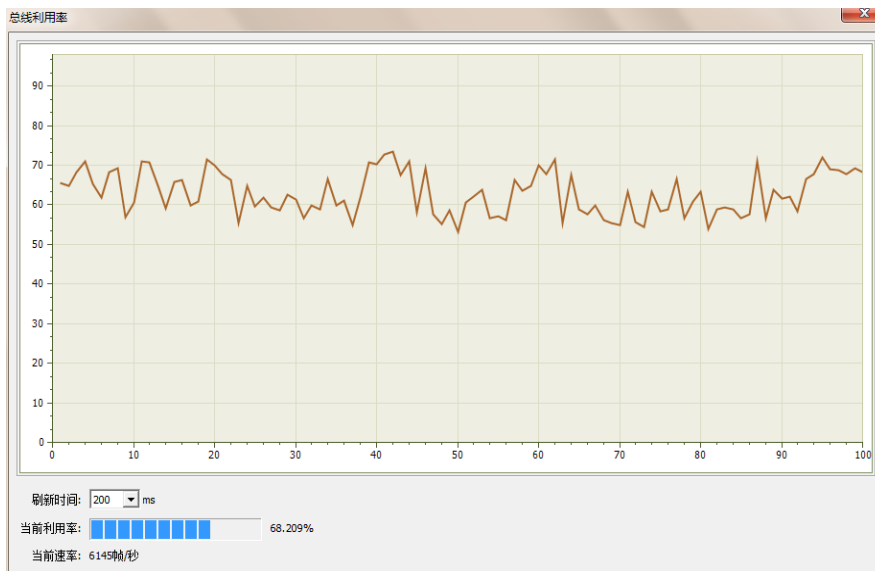
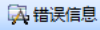
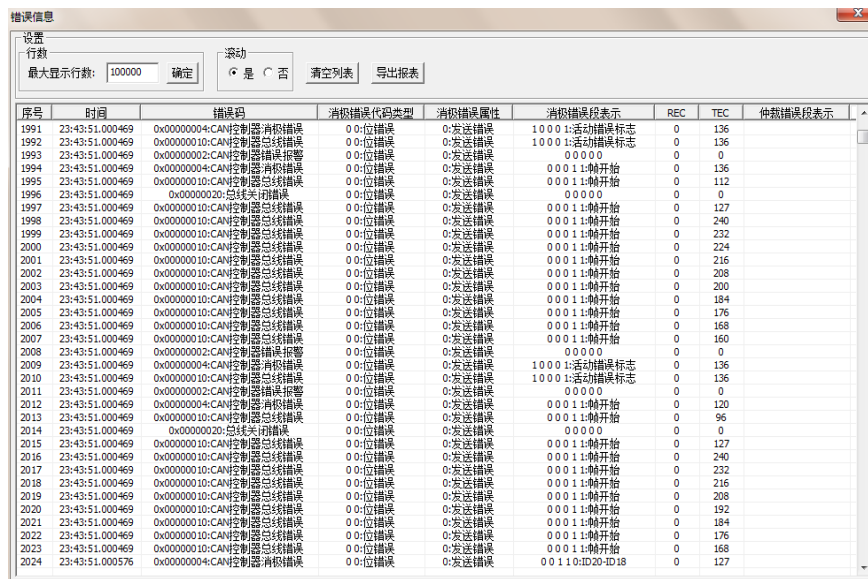

Figure 4.20 Bus utilization

### 4.2.7 Error Message Display

Click  错误信息 to display the error information display interface. When an error occurs in the corresponding CAN circuit, the error message (error sending counter and error receiving counter values), and the time when the error occurred will be printed out. See Figure 4.21.



序号	时间	错误码	消极错误代码类型	消极错误属性	消极错误表示	REC	TEC	仲裁错误表示
1991	23:43:51.000469	0x0000004:CAN控制器清除错误	0:位错误	0:发送错误	10001:活动错误标志	0	136	
1992	23:43:51.000469	0x0000010:CAN控制器总线错误	0:位错误	0:发送错误	10001:活动错误标志	0	136	
1993	23:43:51.000469	0x0000002:CAN控制器错误报警	0:位错误	0:发送错误	00000	0	0	
1994	23:43:51.000469	0x0000004:CAN控制器清除错误	0:位错误	0:发送错误	00011:帧开始	0	136	
1995	23:43:51.000469	0x0000010:CAN控制器总线错误	0:位错误	0:发送错误	00011:帧开始	0	112	
1996	23:43:51.000469	0x0000020:总线关闭错误	0:位错误	0:发送错误	00000	0	0	
1997	23:43:51.000469	0x0000010:CAN控制器总线错误	0:位错误	0:发送错误	00011:帧开始	0	127	
1998	23:43:51.000469	0x0000010:CAN控制器总线错误	0:位错误	0:发送错误	00011:帧开始	0	240	
1999	23:43:51.000469	0x0000010:CAN控制器总线错误	0:位错误	0:发送错误	00011:帧开始	0	232	
2000	23:43:51.000469	0x0000010:CAN控制器总线错误	0:位错误	0:发送错误	00011:帧开始	0	224	
2001	23:43:51.000469	0x0000010:CAN控制器总线错误	0:位错误	0:发送错误	00011:帧开始	0	216	
2002	23:43:51.000469	0x0000010:CAN控制器总线错误	0:位错误	0:发送错误	00011:帧开始	0	208	
2003	23:43:51.000469	0x0000010:CAN控制器总线错误	0:位错误	0:发送错误	00011:帧开始	0	200	
2004	23:43:51.000469	0x0000010:CAN控制器总线错误	0:位错误	0:发送错误	00011:帧开始	0	184	
2005	23:43:51.000469	0x0000010:CAN控制器总线错误	0:位错误	0:发送错误	00011:帧开始	0	176	
2006	23:43:51.000469	0x0000010:CAN控制器总线错误	0:位错误	0:发送错误	00011:帧开始	0	168	
2007	23:43:51.000469	0x0000010:CAN控制器总线错误	0:位错误	0:发送错误	00011:帧开始	0	160	
2008	23:43:51.000469	0x0000002:CAN控制器错误报警	0:位错误	0:发送错误	00000	0	0	
2009	23:43:51.000469	0x0000004:CAN控制器清除错误	0:位错误	0:发送错误	10001:活动错误标志	0	136	
2010	23:43:51.000469	0x0000010:CAN控制器总线错误	0:位错误	0:发送错误	10001:活动错误标志	0	136	
2011	23:43:51.000469	0x0000002:CAN控制器错误报警	0:位错误	0:发送错误	00000	0	0	
2012	23:43:51.000469	0x0000004:CAN控制器清除错误	0:位错误	0:发送错误	00011:帧开始	0	120	
2013	23:43:51.000469	0x0000010:CAN控制器总线错误	0:位错误	0:发送错误	00011:帧开始	0	96	
2014	23:43:51.000469	0x0000020:总线关闭错误	0:位错误	0:发送错误	00000	0	0	
2015	23:43:51.000469	0x0000010:CAN控制器总线错误	0:位错误	0:发送错误	00011:帧开始	0	127	
2016	23:43:51.000469	0x0000010:CAN控制器总线错误	0:位错误	0:发送错误	00011:帧开始	0	240	
2017	23:43:51.000469	0x0000010:CAN控制器总线错误	0:位错误	0:发送错误	00011:帧开始	0	232	
2018	23:43:51.000469	0x0000010:CAN控制器总线错误	0:位错误	0:发送错误	00011:帧开始	0	216	
2019	23:43:51.000469	0x0000010:CAN控制器总线错误	0:位错误	0:发送错误	00011:帧开始	0	208	
2020	23:43:51.000469	0x0000010:CAN控制器总线错误	0:位错误	0:发送错误	00011:帧开始	0	192	
2021	23:43:51.000469	0x0000010:CAN控制器总线错误	0:位错误	0:发送错误	00011:帧开始	0	184	
2022	23:43:51.000469	0x0000010:CAN控制器总线错误	0:位错误	0:发送错误	00011:帧开始	0	176	
2023	23:43:51.000469	0x0000010:CAN控制器总线错误	0:位错误	0:发送错误	00011:帧开始	0	168	
2024	23:43:51.000576	0x0000004:CAN控制器清除错误	0:位错误	0:发送错误	00110:ID20-ID18	0	127	

Figure 4.21 Error message

## 5. Method of Using The Interface Library Functions

Efficient and easy-to-use secondary development functions, which support various development environments, such as VC, C#, and Labview.

### 5.1 Methods of Calling the Dynamic Library on Windows

First, put the library function files in the working directory. The library function file has three files ControlCAN.h, ControlCAN.lib, ControlCAN.dll and the kernelDlls folder in total.

#### 5.1.1 Methods of VC Calling the Dynamic Library

- (1) The ControlCAN.h header file is included in the .CPP file.

Such as: #include "ControlCAN.h"

- (2) Connect to the ControlCAN.lib file in the connector settings of the project.

For example: in the VC7 environment, add ControlCAN.lib in the configuration properties → connector → input → additional dependencies on the project property page

#### 5.1.2 Method of VB Calling the Dynamic Library

It can be called after declaring it in the following method.

Syntax:

[Public | Private] Declare Function name Lib "libname" [Alias "aliasname"] [(arglist)] [As type]

The syntax of the Declare statement consists of the following parts:

Public (optional)

Used to declare functions available to all procedures in all modules.

Private (optional)

Used to declare a function that can only be used in the module that contains the declaration.

Name (mandatory)

Any valid function name. The entry points of a dynamic link library are case-sensitive.

Libname (mandatory)

Contains the declared function dynamic link library name or code resource name.

Alias (optional)

Indicates that the function to be called has another name in the dynamic link library (DLL). This parameter can be used when the external function name has the same name as a function. Alias can also be used when a dynamic link library function has the same name as a public variable, constant or any other procedure in the same scope. Alias can also be used if a character in the dynamic link library function does not conform to the naming convention of the dynamic link library.

Aliasname (optional)



Dynamic link library. If the first character is not a number sign (#), aliasname is the name at the entry point of the function in the dynamic link library. If the first character is (#), the following characters must specify the sequence number at the entry to the function.

#### Arglist (optional)

Indicates a variable table that needs to pass parameters when calling the function.

#### Type (optional)

Data type of the return value of Function; it can be Byte, Boolean, Integer, Long, Currency, Single, Double, Decimal (not supported currently), Date, String (variable-length only), or Variant, a user-defined type, or an object type .

The syntax of the arglist parameter is as follows:

[Optional] [ByVal | ByRef] [ParamArray] varname[( )] [As type]

Partial description:

#### Optional

Indicates that the parameter is optional. If this option is used, subsequent arguments in arglist must be optional and must all be declared with the Optional keyword. If ParamArray is used, Optional cannot be used for any parameter.

#### ByVal (optional)

Indicates that the parameter is passed by value.

#### ByRef (optional)

Indicates that the parameter is passed by address.

For example:

```
Public Declare Function VCI_OpenDevice Lib "ControlCAN" (ByVal devicetype As Long,
ByVal deviceind As Long, ByVal reserved As Long) As Long
```

## 5.2 Interface Library Function Usage Process

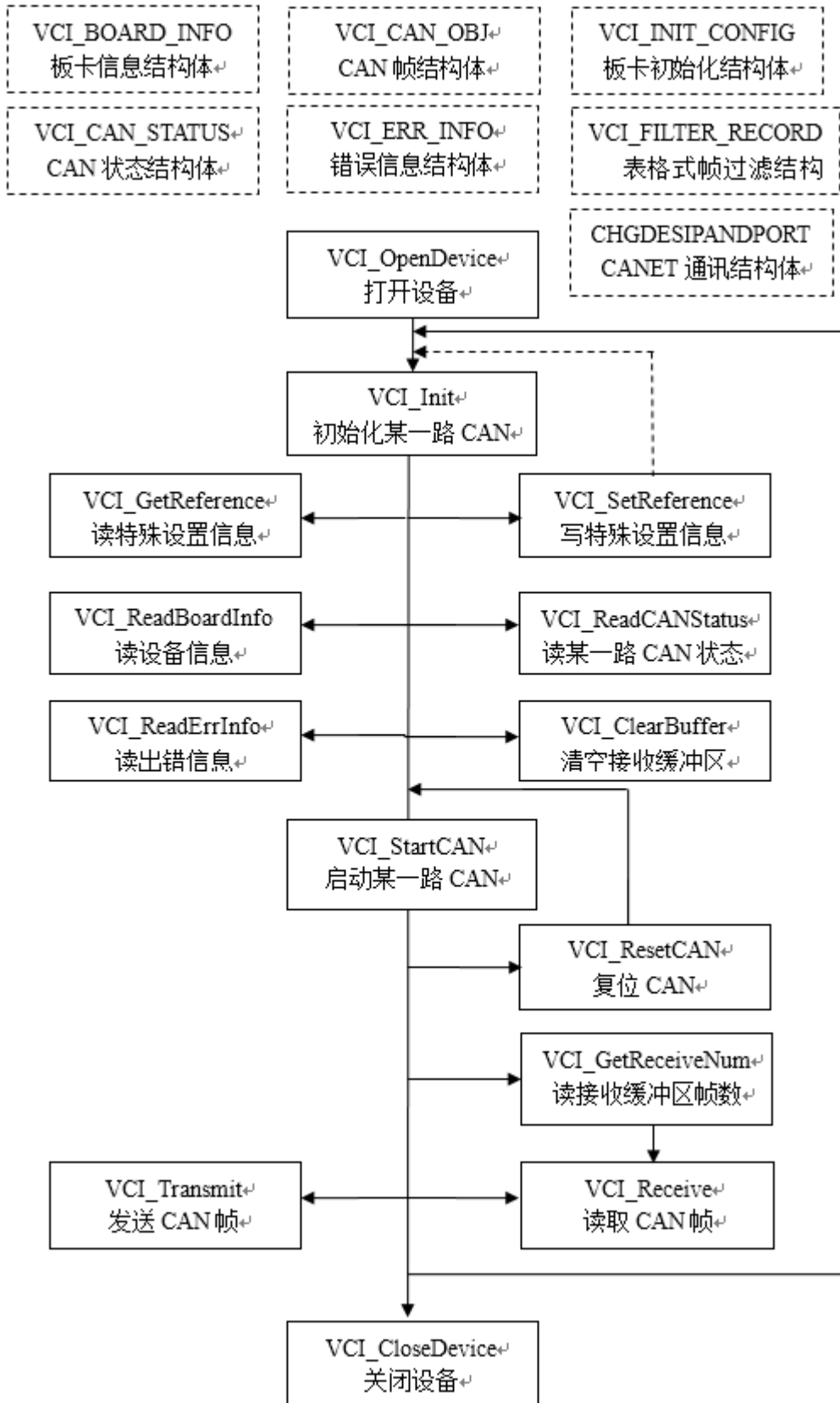

## 6. Electrical Characteristics

Unless otherwise specified, the parameters listed in the following table refer to the value at  $T_{amb}=25^{\circ}C$ . See Table 6.1.

Table 6.1 Electrical characteristics

Parameter Name	Typical Value	Remarks
Power voltage	3.3V	
Operating current	200 mA (+3.3V supply voltage)	
Static level	4 kV (contact)/8 kV (air)	
Range of temperature	-40~+85°C	

### 7. Structure and Dimensions

Board dimensions: 30 mm (width) x 50.95 mm (length) x 7.35 mm (height). The following figure shows the detailed dimensions:

Unit: mm

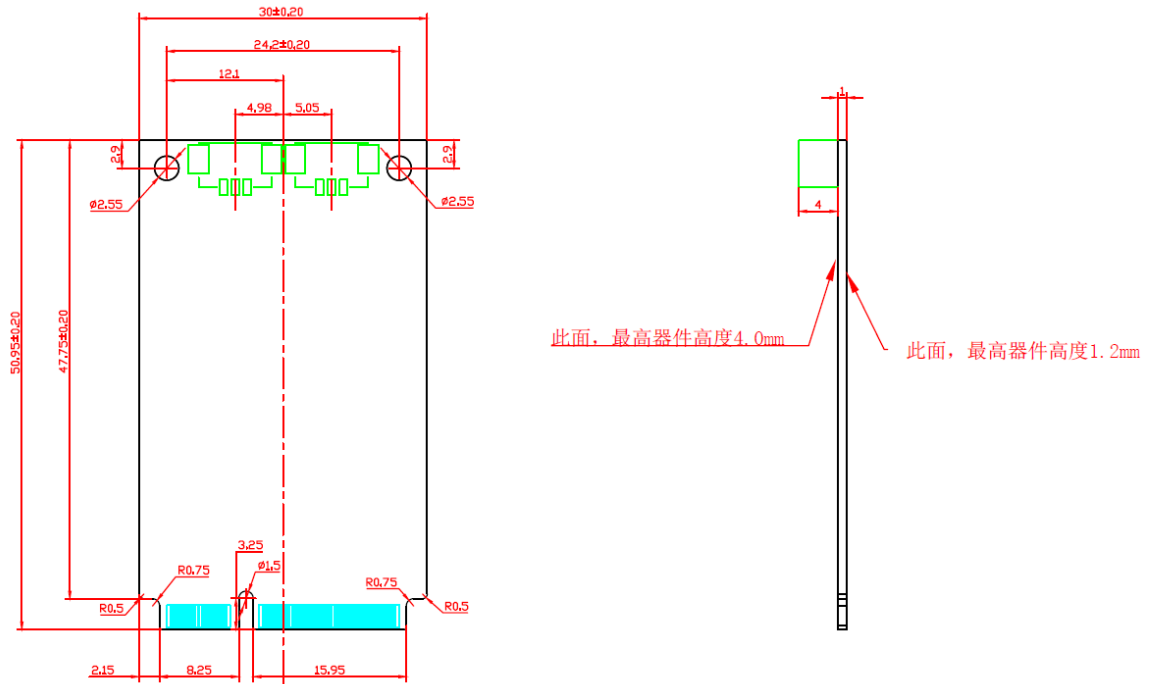

Figure 7.1 Structural dimensions

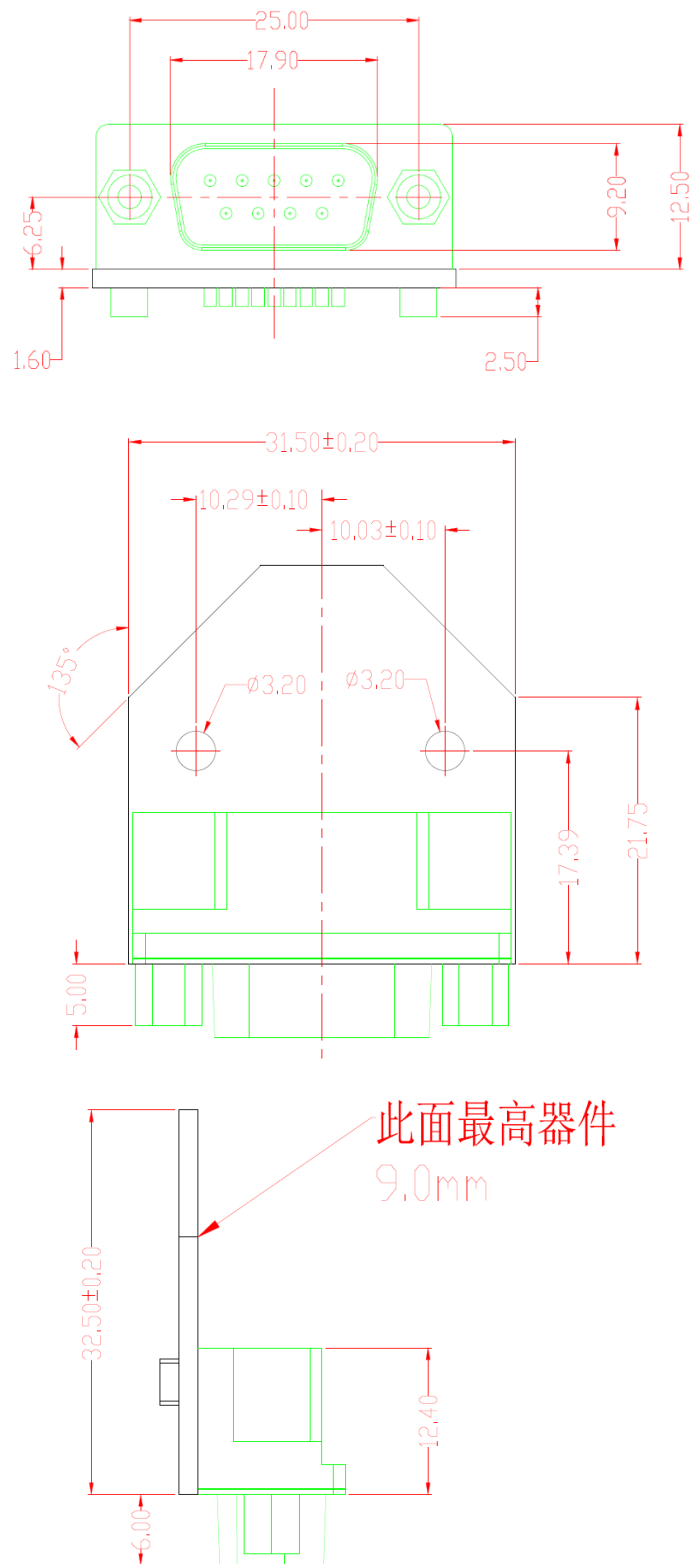

Figure 7.2 PACK board dimensions

## 8. Inspection and Maintenance

The main electrical components of the MiniPCle interface CAN card are semiconductor components. Although it has a long life, it may also age quickly under inappropriate conditions. Periodic inspections should be carried out to ensure that the required conditions are maintained. It is recommended to check at least once every 6 months to a year. Under unfavorable environmental conditions, more frequent inspections should be carried out.

If you encounter a problem during the maintenance, see Table 8.1 to identify the fault cause. If the fault persists, contact Guangzhou ZLG Electronics Co., Ltd.

Table 8.1 Inspection and maintenance

No.	Item	Inspection	Standard	Action
1	Power supply	Check for voltage fluctuations at the power supply side	MiniPCle power supply +3.3 V DC	Check the supply voltage with a voltmeter.
2	Surrounding environment	Check the ambient temperature (including the internal temperature of the enclosed environment)	-40°C ~ +85°C	Use a thermometer to check the temperature and ensure that the ambient temperature is kept within the allowable range
		Check the ambient humidity (including the internal humidity of the enclosed environment)	The humidity must be between 10% and 90% RH when there is no air conditioner	Use a hygrometer to check the humidity and ensure that the ambient humidity is kept within the allowable range
		Check for dust, powder, salt, metal chips	No accumulation	Clean and protect the equipment

		Check that water, oil or chemical spray should not touch the equipment	No spray touches the device	To clean and protect the equipment
		Check for corrosive or flammable gases in the equipment area	No corrosive or flammable gas	Check by smelling or using a sensor
		Check vibration and shock levels	Vibration and shock are within the specified range	If necessary, install gaskets or other shock absorbers
		Check the noise source near the equipment	No significant noise signal source	Isolate the device from the noise source or protect the device
3	Installation and Wiring	Check that each unit is securely connected and has been safely locked with the next unit	No looseness	Press the connectors together completely and lock them with the slider

No.	Item	Inspection	Standard	Action
3	Installation and Wiring	Check that the cable connector is fully inserted and locked	No looseness	Correct any incorrectly installed connectors
		Check for loose screws in external wiring	No looseness	Tighten the screws with a screwdriver
		Check crimp connectors in external wiring	Leave enough space between connectors	Visual inspection. Adjust if necessary
		Check for damage to external cables	No damage	Visual inspection. Replace the cable if necessary



## 9. Disclaimer

Based on the principle of providing better service for users, Guangzhou ZLG Electronics Co., Ltd. ("ZLG Electronics") will try to present detailed and accurate product information in this manual. However, due to the effectiveness of this manual within a particular period of time, ZLG Electronics does not guarantee the applicability of this document at any time. ZLG Electronics shall reserve the right to update this manual without prior notice. To get the latest version, please visit the official website of ZLG Electronics regularly or contact ZLG Electronics. Thank you!

## Appendix A ARM standard baud rate

No.	Baudrate (Kbps)	Crystal frequency = 36 MHz
		Custom baud rate register (bit timing)
1	5	0x003AC1C1
2	10*	0x003AC0E0
3	20*	0x004DC059
4	40	0x004DC02C
5	50*	0x003AC02C
6	80	0x003AC01B
7	100*	0x004DC011
8	125*	0x003AC011
9	200	0x004DC008
10	250*	0x003AC008
11	400	0x0039C005
12	500*	0x003CC003
13	666	0x003CC002
14	800*	0x0039C002
15	1000*	0x003CC001

Note: The ones marked with \* are the baud rates recommended by the CIA Association.

Stay Truthful for Win-win Results, Continuous Learning, Customer  
Oriented, Professional and Concentrated, Always be the No. 1

**Guangzhou ZLG  
Electronics Co., Ltd.**

**广州致远电子股份有限公司**

For more details, please visit  
[www.zlg.cn](http://www.zlg.cn)

Welcome to call the national service hotline  
**400-888-4005**

更多详情请访问  
[www.zlg.cn](http://www.zlg.cn)

欢迎拨打全国服务热线  
**400-888-4005**

